

Exterior LED Lamp Wall Sconce

EW1714
INSTALLATION SHEET

START FROM HERE

- Make sure power is completely off at the fuse box.
- Have your fixture installed by a qualified licensed electrician
- Prepare everything in a clear area.
- Wear gloves at all times during this installation.
- Read instructions carefully before you start assembly.
- Keep this instruction sheet for future reference.

Technical Support: 1-877-452-6858

Please Note:

- All Kuzco LED fixtures come with pre-wired LED module(s).
- Unless instructed to do so, please do not touch any part of the LED module(s) as any unnecessary contact with the module could cause permanent damage.
- For dimming, an ELV (Electronic Low Voltage) type of dimmer is required.

- 1.** Remove the fixture from its original packaging. Remove the mounting plate **(1d)** from within the canopy **(2b)** and attach it to the electrical junction box **(1a)**, using the two screws **(2a)** provided in the hardware package.
- 2.** Attach the canopy backplate **(2b)** to the mounting plate **(1d)**, which is attached to the electrical junction box **(1a)** on the wall. First attach all wiring **(1b)** with the provided marrets (white to white "N", black to black "L", ground to ground "G"). Now push the canopy backplate **(2b)** onto the mounting plate **(1d)** allow the screws **(1c)** to pass through the backplate holes **(2c)**. Next, thread the nuts and washers **(2d)** onto the screws **(1c)** this will secure the fixture to the wall.
- 3.** Next place the gasket **(3a)** onto the canopy backplate **(2b)**, second the diffuser **(3b)**, followed by the casing **(3c)** and secure with the four screws **(3d)**.
- 4.** To prevent moisture from entering the outlet box and causing a short, seal around the top and side perimeter between the fixture and the wall surface with weather resistant caulking (see illustration 3). The space at bottom should be left un-caulked to prevent moisture build-up. Apply a small amount of weather resistant caulking around the side perimeter between the cap nut and mounting plate.
- 5.** You have now completed the installation of your fixture, enjoy.

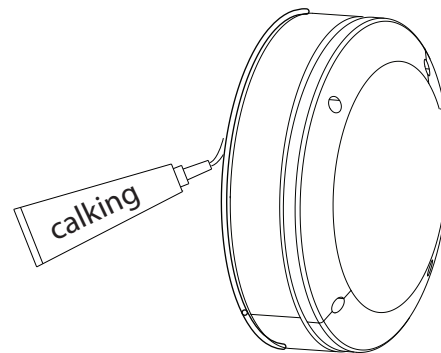
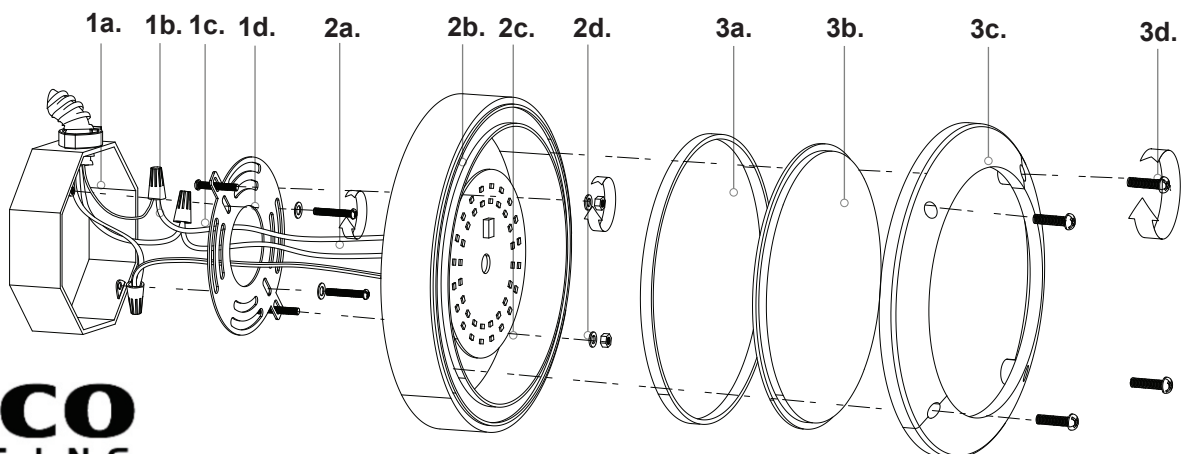

illustration 3



KUZCO
LIGHTING

19054 28th Avenue Surrey, BC Canada V3S 6M3
T: 604 538 7162 TF: 1-855 85 KUZCO F: 604 538 7196
W: kuzcolighting.com
20160726